

THIS DRAWING IS SUPPLIED FOR INFORMATION ONLY. DESIGN FEATURES, SPECIFICATIONS AND PERFORMANCE DATA SHOWN HEREON ARE THE PROPERTY OF THE AMPHENOL CORPORATION. NO RIGHTS OF REPRODUCTION ARE IMPLIED. ALL DIMENSIONS ARE SUBJECT TO NORMAL MANUFACTURING VARIATIONS.

1 2 3 4 5 6 7 8

REV#	REVISION ACTION	REV.BY:	APPR.BY:	DATE
A	Add Logo View.	Fred	JL	08/24/2018

CUSTOMER DRAWING

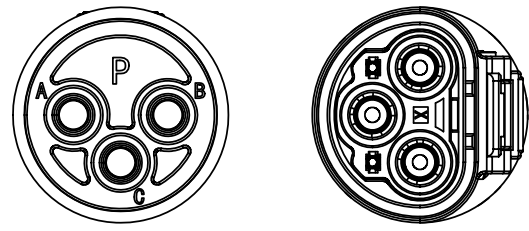

视图 P
比例 1:1

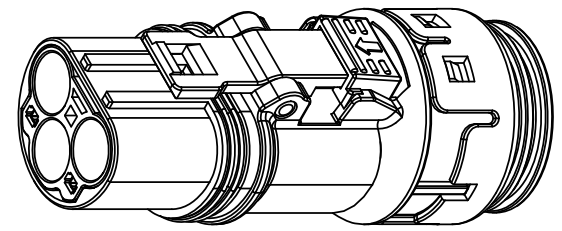
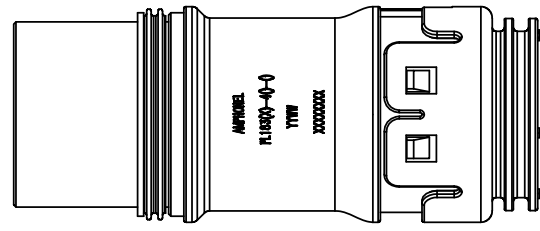
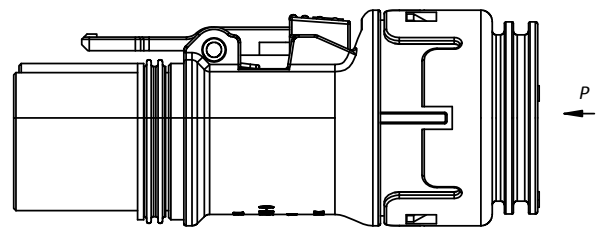
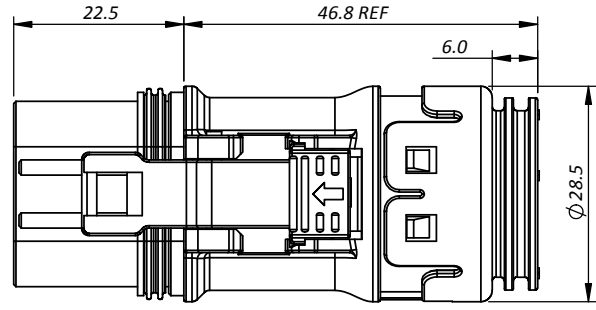
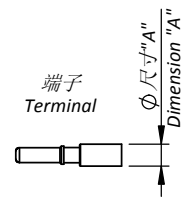

- 规格参数(Spec.):
1. 工作温度 Operating temperature: -40°C~+125°C.
 2. 带高压互锁 Electrical interlock (HVIL)(Optional).
 3. 额定电流 Rating current:
2.5mm²: 25A, 4mm²: 40A, 6mm²: 45A.
 4. 额定电压 Rating voltage: 600 VAC (Max) / 1000 VDC (Max).
 5. 耐电压 Dielectric withstanding voltage: 2200 VAC / 5000 VDC.
 6. 防护等级 Protection class: IP67(mated condition).
 7. 电磁屏蔽 Shielding.
 8. 机械寿命 Mating cycle:100 Min.
 9. 对配插座见图纸 Mating receptacle see drawing: "PL083-40".
 10. 接屏蔽线 Accepted Shielding Wire.

Standard Part List(With HVIL)

Model NO.	Recommended Shielding Wire OD	Dimension "A"	Mating Rcpt Model NO.
PL183X-41-2.5	5.0~5.4mm	Ø 3.70mm	PL083X-41-2.5
PL183Y-41-2.5			PL083Y-41-2.5
PL183U-41-2.5			PL083U-41-2.5
PL183X-41-4	5.6~6.0mm	Ø 4.57mm	PL083X-41-4
PL183Y-41-4			PL083Y-41-4
PL183U-41-4			PL083U-41-4
PL183X-41-6	6.4~7.0mm	Ø 5.80mm	PL083X-41-6
PL183Y-41-6			PL083Y-41-6
PL183U-41-6			PL083U-41-6

Standard Part List(Without HVIL)

Model NO.	Recommended Shielding Wire OD	Dimension "A"	Mating Rcpt Model NO.
PL183X-40-2.5	5.0~5.4mm	Ø 3.70mm	PL083X-40-2.5
PL183Y-40-2.5			PL083Y-40-2.5
PL183U-40-2.5			PL083U-40-2.5
PL183X-40-4	5.6~6.0mm	Ø 4.57mm	PL083X-40-4
PL183Y-40-4			PL083Y-40-4
PL183U-40-4			PL083U-40-4
PL183X-40-6	6.4~7.0mm	Ø 5.80mm	PL083X-40-6
PL183Y-40-6			PL083Y-40-6
PL183U-40-6			PL083U-40-6

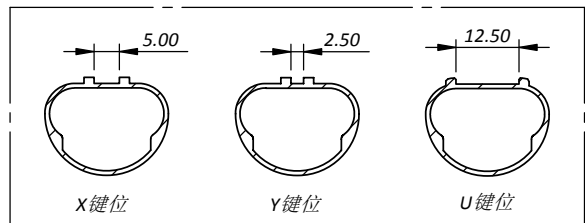

键位示意图

订购信息 Ordering Information

PL183 X - 4 1 - 6

键位及颜色 Key & Color "X", 橙色 Orange "Y", 黑色 Black "U", 黄色 Yellow	高压互锁 HVIL 0, 不带高压互锁 No HVIL 1, 带高压互锁 With HVIL	线缆大小 Cable Size "6"=6mm ² "4"=4mm ² "2.5"=2.5mm ²
--	--	---

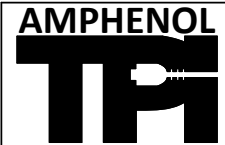

Amphenol Technical Products International Asia.

第三角投影 THIRD ANGLE PROJECTION	页面 SHEET	幅面 SIZE	版次 REV.	比例 SCALE	PART NAME: PwrLok 3.6mm 3POS Plug Conn
1 OF 1	A4	A			DWG NO: PL183X-40
签名 SIGNATURE	日期 DATE	UNLESS OTHERWISE SPECIFIED 1) All dimensions are in metric(mm). 2) Tolerances are as follows: 1.PL DEC ± 1.00 2.PL DEC ± 0.50 3.PL DEC ± 0.20			DWG NO: PL183X-40
制图 DRAWN	Fred	08/24/2018	CUST PART # N/A		
审核 CHECKED			CUST REV. -		
批准 APPROVAL			Angles ±1°		

1 2 3 4 5 6 7 8

THIS DRAWING IS SUPPLIED FOR INFORMATION ONLY. DESIGN FEATURES, SPECIFICATIONS AND PERFORMANCE DATA SHOWN HEREON ARE THE PROPERTY OF THE AMPHENOL CORPORATION. NO RIGHTS OF REPRODUCTION ARE IMPLIED. ALL DIMENSIONS ARE SUBJECT TO NORMAL MANUFACTURING VARIATIONS.

CUSTOMER DRAWING

REV#	REVISION ACTION	REV.BY:	APPR.BY:	DATE
A	Add Logo View.	Fred	JL	08/24/2018



视图P
比例 1:1

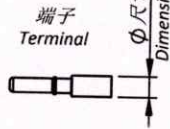
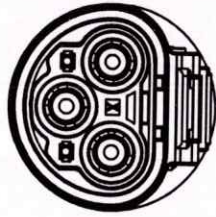

Standard Part List(With HVIL)

Model NO.	Recommended Shielding Wire OD	Dimension "A"	Mating Rcpt Model NO.
PL183X-41-2.5	5.0~5.4mm	Φ 3.70mm	PL083X-41-2.5
PL183Y-41-2.5			PL083Y-41-2.5
PL183U-41-2.5			PL083U-41-2.5
PL183X-41-4	5.6~6.0mm	Φ 4.57mm	PL083X-41-4
PL183Y-41-4			PL083Y-41-4
PL183U-41-4			PL083U-41-4
PL183X-41-6	6.4~7.0mm	Φ 5.80mm	PL083X-41-6
PL183Y-41-6			PL083Y-41-6
PL183U-41-6			PL083U-41-6

Standard Part List(Without HVIL)

Model NO.	Recommended Shielding Wire OD	Dimension "A"	Mating Rcpt Model NO.
PL183X-40-2.5	5.0~5.4mm	Φ 3.70mm	PL083X-40-2.5
PL183Y-40-2.5			PL083Y-40-2.5
PL183U-40-2.5			PL083U-40-2.5
PL183X-40-4	5.6~6.0mm	Φ 4.57mm	PL083X-40-4
PL183Y-40-4			PL083Y-40-4
PL183U-40-4			PL083U-40-4
PL183X-40-6	6.4~7.0mm	Φ 5.80mm	PL083X-40-6
PL183Y-40-6			PL083Y-40-6
PL183U-40-6			PL083U-40-6

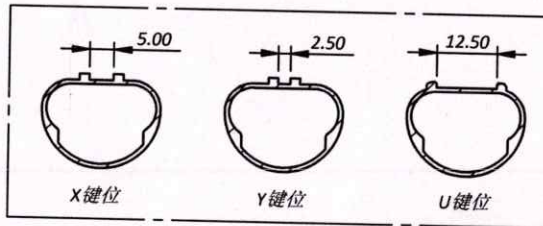
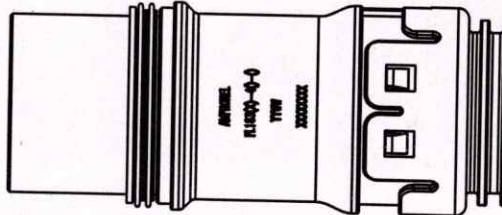
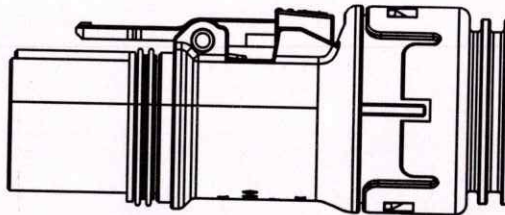
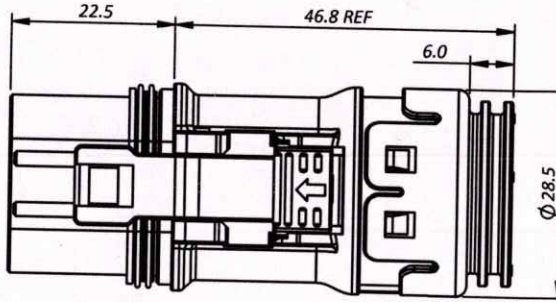

键位示意图

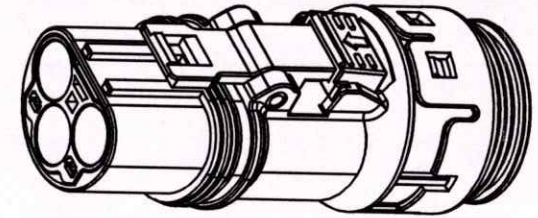

规格参数(Spec.):

1. 工作温度 Operating temperature: -40°C~+125°C.
2. 带高压互锁 Electrical interlock (HVIL)(Optional).
3. 额定电流 Rating current:
2.5mm²: 25A, 4mm²: 40A, 6mm²: 45A.
4. 额定电压 Rating voltage: 600 VAC (Max) / 1000 VDC (Max).
5. 耐电压 Dielectric withstanding voltage: 2200 VAC / 5000 VDC.
6. 防护等级 Protection class: IP67(mated condition).
7. 电磁屏蔽 Shielding.
8. 机械寿命 Mating cycle: 100 Min.
9. 对配插座见图纸 Mating receptacle see drawing: "PL083-40".
10. 接屏蔽线 Accepted Shielding Wire.

订购信息 Ordering Information



Amphenol TPI
2018-09-10
REGISTERED COPY

AMPHENOL TPI	Amphenol Technical Products International Asia.				
	第三角投影 THIRD ANGLE PROJECTION	页 面 SHEET	幅 面 SIZE	版 次 REV.	比 例 SCALE
签 名 SIGNATURE	日 期 DATE	UNLESS OTHERWISE SPECIFIED 1) All dimensions are in metric(mm). 2) Tolerances are as follows: 1.PL DEC ± 1.00 2.PL DEC ± 0.50 3.PL DEC ± 0.20			DWG NO: PL183X-40
制 图 DRAWN	审 核 CHECKED	批 准 APPROVAL	角 度 ±1°		CUST PART # N/A
Fred	08/24/2018	2018.9.7			CUST REV. -